

**ELSAT<sup>®</sup> BUC**  
**Baby BUC**

**L-Band Block Up-converter (BUC)**  
**Operating Manual**

**ELSAT<sup>®</sup> C-Band Series**  
**ELSAT<sup>®</sup> Ku-Band Series**

**Baby BUC Ku-Band Series**

You have just received an AnaCom ELSAT<sup>®</sup> Block Up-Converter (BUC) or Baby BUC, a *cost-effective* product with no compromise on *quality* and *reliability*. This product should provide tireless performance in any reasonable operating environment. Note that this product is transmit only, and does not include a Block Down-Converter, which will have to be obtained separately.

We at AnaCom, have taken great care to provide a convenient, easy-to-use product in a single package. Should a situation arise beyond the operator's control, just give us a telephone call. Many situations can be diagnosed and solved by AnaCom's trained customer-service personnel over the phone.

If you have any questions, require technical assistance or training please call AnaCom directly at (408) 519-2062 or FAX to us at (408) 519.2063. You can also send e-mail to techsupport@anacominc.com and one of our engineers will contact you.

---

---

## ANACOM, INC.

1996 Lundy Ave.  
San Jose, CA 95131  
Tel: (408) 519-2062  
Fax: (408) 519-2063

---

*©2011 AnaCom, Inc. All rights reserved. The information furnished by AnaCom, Incorporated, in this publication is believed to be accurate and reliable. However, no responsibility is assumed by AnaCom for its use, nor any infringements of patents or other rights of third parties resulting from its use. No license is granted by implication or otherwise under any patent or patent right of AnaCom, Inc. AnaCom reserves the right to change circuitry and specifications at any time without prior notice.*

*The following terms are trademarks of their respective holders:*

*AnaSat, ELSAT, AnaCom, Inc.*

*Polyswitch*

*Teflon*

*Duroid*

*INTELSAT*

---

# Operating Manual

for

## AnaCom Block Up-Converters

---

### Table of Contents

ELSAT <sup>®</sup> Quick Start Guide .....	5
Baby BUC Quick Start Guide .....	6
Introduction .....	7
Typical Operating Parameters - ELSAT <sup>®</sup> C-Band .....	8
Typical Operating Parameters - ELSAT <sup>®</sup> Ku-Band .....	9
Typical Operating Parameters - Baby BUC .....	10
Installation .....	11
Unpacking .....	11
Tools and Test Equipment .....	11
Safety Precautions .....	11
General .....	11
Power Supply .....	11
Transmitter .....	11
Power Amplifier .....	12
Site Considerations .....	12
Antenna .....	12
Power Requirements .....	12
BUC Mounting Considerations .....	13
BUC Mounting .....	13
Grounding .....	13
Cable and Waveguide Connections .....	15
Cabling Requirements .....	15
1. AC Power .....	15
1a. Optional Baby BUC DC Power .....	15
2. Transmitter Feed .....	17
3. L-Band Modem .....	17
Final Check .....	17
Water Resistance Wrap .....	17
Operation .....	18
Frequency Programming .....	18
Antenna Adjustment .....	18
Transmit Power Adjustment .....	18
Maintenance .....	19
Fan Replacement .....	19

---

Alarm Relay Closure Option .....	21
Monitored Values.....	21
18-Pin Circular Weathertight Connector .....	21
Appendix A. M & C Command Set.....	22
Alphabetical Listing of M & C Commands .....	22
Command Page .....	22
Block Up-Converter - M & C Commands .....	23
Appendix B. ARM9 M&C Card Connection Methods .....	29
Serial Port Methods.....	29
RS-232 .....	29
RS-485 .....	29
FSK .....	29
Ethernet-based Methods.....	30
Supervisor 9 .....	31
Telnet .....	32
HTTP (web browser) .....	33
SNMP.....	34
LIMITED WARRANTY .....	35

## ELSAT<sup>®</sup> Quick Start Guide

1. Mount the Block Up-Converter (BUC) on the antenna.
2. Connect the required cables/waveguide.  
At a minimum, this includes a TX IF cable from the modem to the RF output cable or waveguide to the antenna OMT TX 1
3. Install a proper power connector on the (included) power cable. Plug the cable into 110 or 240VAC, or optional 48VDC.
4. Configure the L-band Modem & verify the following outputs on the TX IF cable at the BUC:
  - 10 MHz reference: 0 to +10 dBm – if required
  - Transmit IF power input: -15 dBm nominal for rated output. Set the modem power to achieve the required link budget.
5. Set Frequency of operation from the modem.
  - EC-Band BUC: 4900 MHz L.O.**  
950 MHz to 1525 MHz L-Band input → 5850 MHz to 6425 MHz C-Band output
  - SEC-Band BUC: 4900 MHz L.O.**  
950 MHz to 1750 MHz L-Band input → 5850 MHz to 6650 MHz C-Band output
  - Standard Ku-Band BUC: 12800 MHz L.O.**  
1200 MHz to 1700 MHz L-Band input → 14000 MHz to 14500 MHz Ku-Band output
  - Extended Ku-Band BUC: 12800 MHz L.O.**  
950 MHz to 1450 MHz L-Band input → 13750 MHz to 14250 MHz Ku-Band output
  - Super Extended Ku-Band BUC: 12800 MHz L.O.**  
950 MHz to 1700 MHz L-Band input → 13750 MHz to 14500 MHz Ku-Band output



## Baby BUC Quick Start Guide

1. Mount your new compact BUC on the antenna.
2. Connect your PC serial port to the BUC's M&C connector, run DT.exe or Supervisor 2009 on the supplied CD, or your own software if you wish, and configure it to 1200bps, 8 data bits, no parity, 1 stop bit, CR/LF Off. Connection diagrams are in Appendix C of the manual.
3. Install a proper power connector on the included power cable. Plug this cable into the power connector on the side of the BUC, 48VDC if you ordered DC models, or 110 / 240VAC, 50/60Hz if you ordered AC models. Verify that the green LED on the transmitter is blinking, that indicating normal internal operation. The red LED must be OFF, because if illuminated, it indicates an alarm condition and requires attention. Refer to the ALARM command in Appendix A and B of the manual for details.
4. Configure transmit output power as TXGAIN nn ranges from:
 

48 to 58 [2Ku]	51 to 61 [4Ku]
54 to 64 [8Ku]	55 to 65 [8Ku]
57 to 67 [16Ku]	58 to 68 [20Ku]
59 to 69 [25Ku]	60 to 70 [32Ku]
61 to 71 [40Ku]	
5. Enable the transmitter by type in TX ON. TX OFF will take the transmitter OFF air.

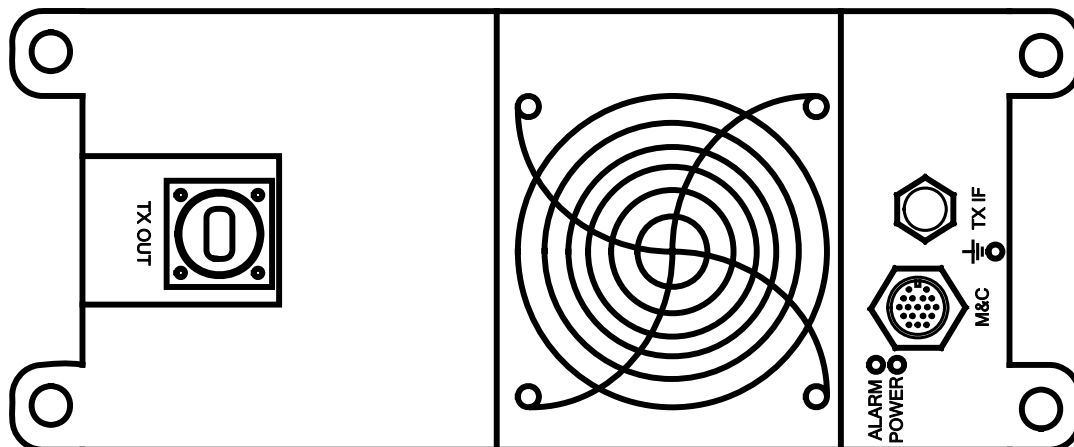

### DC POWER MODELS

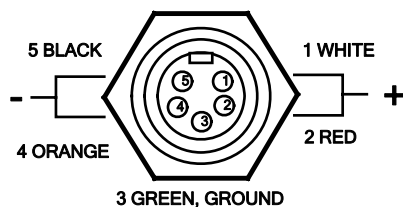

### AC POWER MODELS

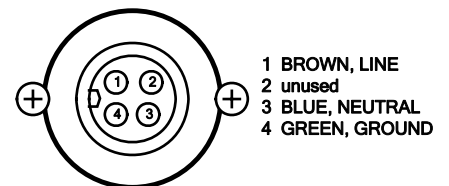

---

## Introduction

The ELSAT® and Baby BUC series of block up-converters (BUC) are designed for continuous outdoor duty in all types of environments. Ideally suited for SCPC, MCPC, DAMA, and VoIP applications. Designed to interface with any L-band modem, the ELSAT® VSAT BUC may be used in a wide variety of communication networks.

The C-band members of the ELSAT® family transmit in the 6 GHz frequency range. The Ku-band members of the ELSAT® and Baby BUC families transmit in the 14 GHz frequency band.

The ELSAT® and Baby BUCs include an L-band up-converter and a solid-state power amplifier (PA), into a small, highly integrated outdoor package. The only cabling required to the indoor plant are the IF and power cables.

The ELSAT® C-band BUC up-converts the modulator's L-band IF output to an RF signal in the 6 GHz range for transmission.

The ELSAT® and Baby Ku-band BUCs up-convert the modulator's L-band IF output to an RF signal in the 14 GHz range for transmission.

Each BUC includes an L-band to RF up-converter, a solid-state Power Amplifier (PA), optional M&C, and a universal A.C. power supply, all in a simple outdoor package.

The Power Amplifier (PA) uses Internally-Matched Field-Effect Transistors (IMFET) to achieve highly linear power and gain with minimal intermodulation distortion (IMD) products.

Each BUC uses a wide input voltage (100 to 240VAC, 47 to 63Hz) switching power supply to develop the +13V used as the internal power source for the power amplifier. An internal circuit senses the input voltage range being used and automatically switches to the appropriate voltage mode. The AC input is connected via a 4-pin circular connector. DC power supplies such as 48V are optional.

BUCs can come equipped with an internal 10 MHz reference. If this option is not present, a 10 MHz reference signal supplied on the TX IF cable from the modulator will be required.



*Figure 1 - ELSAT Block Up-Converter*



*Figure 2 - Baby Block Up-Converter*

## Typical Operating Parameters - ELSAT<sup>®</sup> C-Band

		10W	20W	30W	40W	50W	60W	70W	80W	100W	125W	150W	180W	200W	300W	350W	400W
<b>TRANSMIT CHARACTERISTICS</b>	1 dB COMPRESSION POINT (dBm)	40	43	44.8	46	47	47.8	48.5	49	50	51	51.8	52.6	53	54.8	55.4	56
	TX GAIN	66	69	70.8	71	73	73.8	74.5	75	76	77	77.8	78.6	79	80.4	81.4	82
	TX GAIN RANGE	10 dB variable in 1 dB steps via M&C															
	TX LEVEL FLATNESS	6 dBp-p max / 500 MHz															
	TX GAIN OVER TEMPERATURE	+/- 2dB max															
	TX INPUT IF FREQUENCY	EC = 950 to 1525 MHz					SEC = 950 to 1825 MHz					LMI-EC = 950 to 1650 MHz					
	TX INPUT IF IMPEDANCE	50 ohms (75 ohms optional)															
	TX INPUT IF LEVEL	-25 dBm for rated output with nominal gain															
	TX OUTPUT FREQUENCY	EC = 5.850 to 6.425 GHz					SEC = 5.850 to 6.725 GHz					LMI-EC = 5.725 to 6.425 GHz					
		PC = 6.425 to 6.725 GHz					RC = 5.975 to 6.475 GHz					XC = 6.725 to 7.025GHz					
TX PHASE NOISE	-60 dBc/Hz max @ 100Hz					-70 dBc/Hz max @ 1KHz					-80 dBc/Hz max @ 10KHz						
	-90 dBc/Hz max @ 100KHz					-100 dBc/Hz max @ 1MHz											
INTERMOD	-33 dBc max (2 carriers, each 9 dB backoff from P1dB rating)																
SPURIOUS	-55 dBc max out of band																
<b>REFERENCE</b>	Requirements	Provided on TXIF line by L-band modem															
	FREQUENCY	10 MHz (sine-wave)															
	INPUT POWER	-5 to +5 dBm (at input port)															
	PHASE NOISE	-125 dBc/Hz max @ 100Hz -135 dBc/Hz max @ 1KHz -140 dBc/Hz max @ 10KHz															
	INTERNAL REFERENCE OPTION	10 <sup>-8</sup> over rated temperature															
<b>SYSTEM</b>	ALARM RELAYS	FORM C for Summary Alarm; Isolated															
	POWER	100 to 250 VAC; 47 to 63 Hz								optional 48V DC							
	M&C	Optional RS-232 / RS-485															
<b>ENVIRONMENTAL</b>	TEMPERATURE	-50 to +55°C operational -50 to +75°C storage															
	HUMIDITY	95% at 45C															
	ALTITUDE	6,500 meters (21,500 ft) max															
	RAIN	20 inches per hour															
	WIND	150 miles per hour															
	VIBRATION	1.0 g random operational, 2.5 g random survival															
SHOCK	10 g operational, 40 g survival																
<b>POWER &amp; DIMENSIONS</b>	TYPICAL POWER CONSUMPTION (VA)	125	229	280	390	394	398	570	572	762	1179	1179	1539	1539	2832	2832	2832
	PRIME POWER RECOMMENDATION	340	600	730	870	880	890	1200	1200	1600	2400	2400	3100	3100	6200	6200	6200
	WEIGHT (lbs.)	31	37	40	42	54	54	64	64	64	120	142	142	142	207	207	207
	(kg.)	14	17	18	19	24	24	29	29	29	54	64	64	64	94	94	94
	BUC SIZE: - 10W	21.6" x 9.0" x 9.4" (549 x 229 x 238 mm)															
	- 20W, 30W	21.6" x 9.0" x 10.3" (549 x 229 x 262 mm)															
	- 40W	21.6" x 9.0" x 11.4" (549 x 229 x 289 mm)															
	- 50W, 60W	21.6" x 9.0" x 12.5" (549 x 229 x 317 mm)															
	- 70W, 80W, 100W	21.6" x 13" x 11.2" (549 x 330 x 284 mm)															
	- 125W, 150W, 180W, 200W	34.5" x 12.75" x 12.4" (876 x 324 x 315 mm)															
- 300W, 350W, 400W	34.5" x 25.5" x 12.36" (876 x 648 x 314 mm)																

\*all specifications subject to change

## Typical Operating Parameters - ELSAT<sup>®</sup> Ku-Band

		8W	16W	20W	23W	25W	32W	40W	50W	60W	80W	100W	125W
<b>TRANSMIT CHARACTERISTICS</b>	1 dB COMPRESSION POINT (dBm)	39	42	43	43.6	44	45	46	47	47.8	49	50	51
	TX GAIN	65	68	69	69.6	70	71	72	73	73.8	75	76	77
	TX GAIN RANGE	10 dB variable in 1 dB steps via M&C											
	TX LEVEL FLATNESS	6 dBp-p max / 500 MHz											
	TX GAIN OVER TEMPERATURE	+/- 2dB max											
	TX INPUT IF FREQUENCY	Ku = 1200 to 1700 MHz				EKu = 950 to 1450 MHz				SEKu = 950 to 1,700 MHz			
	TX INPUT IF IMPEDANCE	50 ohms (75 ohms optional)											
	TX INPUT IF LEVEL	-25 dBm for rated output with nominal gain											
	TX L.O.	Ku = 13.050 GHz				EKu = 12.800 GHz				SEKu = 12.8 GHz			
	TX OUTPUT FREQUENCY	Ku = 14.0 to 14.50 GHz				EKu = 13.75 to 14.25 GHz				SEKu = 13.75 to 14.50 GHz			
	TX PHASE NOISE	-60 dBc/Hz max @ 100Hz				-70 dBc/Hz max @ 1KHz				-80 dBc/Hz max @ 10KHz			
		-90 dBc/Hz max @ 100KHz				-100 dBc/Hz max @ 1MHz							
	INTERMOD	-33 dBc max (2 carriers, each 9dB backoff from P1dB rating)											
SPURIOUS	-55 dBc max out of band												

<b>REFERENCE</b>	Requirements	Provided on TXIF line by L-band modem											
	FREQUENCY	10 MHz (sine-wave)											
	INPUT POWER	-5 to +5 dBm (at input port)											
	PHASE NOISE	-125 dBc/Hz max @ 100Hz -135 dBc/Hz max @ 1KHz -140 dBc/Hz max @ 10KHz											
	INTERNAL REFERENCE OPTION	10 <sup>-8</sup> over rated temperature											

<b>SYSTEM</b>	ALARM RELAYS	FORM C for Summary Alarm; Isolated											
	POWER	100 to 250 VAC; 47 to 63 Hz						optional 48V DC					
	M&C	Optional RS-232 / RS-485											

<b>ENVIRONMENTAL</b>	TEMPERATURE	-50 to +55°C operational -50 to +75°C storage											
	HUMIDITY	95% at 45C											
	ALTITUDE	6,500 meters (21,500 ft) max											
	RAIN	20 inches per hour											
	WIND	150 miles per hour											
	VIBRATION	1.0 g random operational, 2.5 g random survival											
	SHOCK	10 g operational, 40 g survival											

<b>POWER &amp; DIMENSIONS</b>	TYPICAL POWER CONSUMPTION (VA)	160	270	294	300	300	340	770	800	850	1430	1600	1640
	PRIME POWER RECOMMENDATION	400	690	700	710	720	850	1700	1800	1900	3100	3500	3600
	WEIGHT (lbs.)	25	35	41	41	41	38	64	64	64	120	129	142
	(kg.)	11	16	19	19	19	17	29	29	29	54	59	64
	BUC SIZE:	- 0W, 2W, 4W      21.6" x 9.0" x 7"      (549 x 229 x 178 mm) - 8W      21.6" x 9.0" x 9.4"      (549 x 229 x 239 mm) - 16W, 20W, 23W, 25W      21.6" x 9.0" x 10.8"      (549 x 229 x 274 mm) - 32W      21.6" x 9.0" x 12.5"      (549 x 229 x 317 mm) - 40W, 50W, 60W      21.6" x 13.0" x 11.2"      (549 x 330 x 345 mm) - 80W, 100W, 125W      38.0" x 12.75" x 12.4"      (965 x 330 x 318 mm)											

\*all specifications subject to change

## Typical Operating Parameters - Baby BUC

<b>Baby BUC</b> Ku-Band series		<b>SPECIFICATIONS</b>								
		8W	16W	25W	32W	40W	50W	60W	80W	100W
<b>TRANSMIT CHARACTERISTICS</b>	1 dB COMPRESSION POINT (dBm)	39	42	44	45	46	47	47.8	49	50
	TX GAIN (Nominal)	64	67	69	70	71	72	72.8	74	75
	TX GAIN RANGE	±10 dB variable in 1 dB steps via M&C								
	TX LEVEL FLATNESS	4 dBp-p max / 500 MHz								
	TX GAIN OVER TEMPERATURE	± 1dB max								
	TX INPUT IF FREQUENCY	Ku = 950 to 1450 MHz			EKu = 950 to 1450 MHz			SEKu = 950 to 1,700 MHz		
	TX INPUT IF IMPEDANCE	50 ohms (75 ohms optional)								
	TX INPUT IF LEVEL	-25 dBm for rated output with nominal gain								
	TX L.O. FREQUENCY	Ku = 13.050 GHz			EKu = 12.800 GHz			SEKu = 12.800 GHz		
	TX OUTPUT FREQUENCY	Ku = 14.0 to 14.50 GHz			EKu = 13.75 to 14.25 GHz			SEKu = 13.75 to 14.50 GHz		
TX PHASE NOISE	-60 dBc/Hz max @ 100Hz			-70 dBc/Hz max @ 1KHz			-80 dBc/Hz max @ 10KHz			
	-90 dBc/Hz max @ 100KHz			-100 dBc/Hz max @ 1MHz						
INTERMOD	-32 dBc max (2 carriers, each 9dB backoff from P1dB rating)									
SPURIOUS	-55 dBc max out of band									
<b>REFERENCE</b>	Requirements	Provided on TXIF line by L-band modem								
	FREQUENCY	10 MHz (sine-wave)								
	INPUT POWER	-5 to +5 dBm (at input port)								
	PHASE NOISE	-125 dBc/Hz max @ 100Hz								
		-135 dBc/Hz max @ 1KHz								
INTERNAL REFERENCE OPTION	10 <sup>-8</sup> over rated temperature									
<b>SYSTEM</b>	ALARM RELAYS	FORM C for Summary Alarm; Isolated								
	POWER	100 to 250 VAC; 47 to 63 Hz				optional 48V DC				
	M&C	SNMP, HTTP, Telnet			Ethernet, RS-232, RS-485, FSK					
<b>ENVIRONMENTAL</b>	TEMPERATURE	-50 to +55°C operational -50 to +75°C storage								
	HUMIDITY	95% at 45C								
	ALTITUDE	6,500 meters (21,500 ft) max								
	RAIN	20 inches per hour								
	WIND	150 miles per hour								
	VIBRATION	1.0 g random operational, 2.5 g random survival								
SHOCK	10 g operational, 40 g survival									
<b>POWER &amp; DIMENSIONS</b>	TYPICAL POWER CONSUMPTION (VA)	111	189	256	266	372	392	850	935	950
	PRIME POWER RECOMMENDATION	220	380	500	532	750	784	1700	1870	1900
	WEIGHT: 48V DC 110/220V AC	14 lbs. (6 kg) 16.4 lbs. (7 kg)	15 lbs. (7 kg) 17.4 lbs. (8 kg)	15.5 lbs. (7 kg) 17.9 lbs. (8 kg)		17.5 lbs. (8 kg) 19.9 lbs. (9 kg)		61 lbs. (28 kg) 64 lbs. (29 kg)	67 lbs. (30 kg) 72 lbs. (33 kg)	
BUC SIZE: 48V DC 110/220V AC	13.3" x 6.3" x 7.4" 13.3" x 6.3" x 8.4"				13.3" x 6.3" x 8.4" 13.3" x 6.3" x 9.4"		21.6" x 12.93" x 11.2"	21.6" x 12.93" x 13.53"		

\*all specifications subject to change

## Installation



*Removal of any cover may jeopardize the weather seal, which may cause problems later.*

## Unpacking

Check to make sure that the Block Up-Converter has not suffered any damage in shipment. Compare contents of the crate to ensure items received match those listed on the packing slip. Retain all shipping containers for future use.

## Tools and Test Equipment

Have on-hand a standard electrician's tool kit and any tools listed in your antenna installation instructions.

## Safety Precautions

### General



*Observe normal safety precautions when operating this equipment.*

Ensure the BUC is properly grounded. Do not rely on coaxial cable shields for the ground connection.

If the cover is removed from any AnaCom product, ensure that all:

- gaskets are intact and free of damage prior to reinstallation
- mounting screws are properly installed

Ensure all connectors are properly waterproofed.

### Power Supply

Confirm that AC Power is disconnected before removing the Block Up-Converter cover.

### Transmitter

Take adequate precautions to ensure the BUC output does not transmit a signal until it has been properly connected and set up for authorized frequencies and power levels.



*Transmitter RF output power levels are adequate to cause blindness or other serious injury to body tissues. Use caution when working around the Block Up-Converter or antenna when the system is active.*

### ***Power Amplifier***

Be sure the Block Up-Converter TX OUT port is properly terminated prior to operation. Ensure all the correct waveguide gaskets are used to prevent water damage.

TO ENSURE PROTECTION OF PERSONNEL AND EQUIPMENT, USE CARE DURING ANTENNA INSTALLATION AND WHENEVER WORKING ON OR AROUND THE SYSTEM.

## **Site Considerations**

The installation requirements of any particular site are the responsibility of the system operator. AnaCom offers an optional installation mounting kit, that can be used at most sites. Contact AnaCom for details.

### ***Antenna***

The Block Up-Converter must be attached to some form of mounting structure which is usually the antenna feed boom or the antenna support structure. Specific mounting procedures will depend on the antenna used. ELSAT® and Baby Block Up-Converters are designed to be mounted on most antennas. Locate and install the antenna according to the antenna manufacturer's instructions. Choose an area that is free of extraneous interference from motors and electronic equipment and has a clear line-of-sight from the antenna to the satellite.

Lightning arrestors should be used at the site to protect personnel and equipment. Size 3/0 or 4/0 stranded copper wire should be used to bond the Block Up-Converter to the antenna frame and to the lightning protection ground rod.

### ***Power Requirements***

Each BUC contains an internal universal AC power supply that supplies both the converter and PA internal subassemblies.

AnaCom's BUCs require 110 VAC or 220 VAC at 50 or 60 Hz, through a circuit breaker. The size of the circuit breaker depends on model. To assure uninterrupted service, some method of back-up AC power is recommended. Installing surge arrestors and AC power line filters will reduce voltage surges from the AC power input. Provide an isolation filter to clean up power line interference and/or voltage variations, as required.

NOTE: AC TRANSIENTS AND SURGES MAY CAUSE DATA TRANSMISSION ERRORS AND LOSS OF SYNCHRONIZATION IN THE BLOCK UP-CONVERTER SYNTHESIZERS AND/OR THE EXTERNAL MODEM EQUIPMENT.

## BUC Mounting Considerations

The ELSAT® BUC must be mounted such that:

1. Sufficient support is afforded the Block Up-Converter to minimize the effects of antenna sway in strong winds.
2. Air movement is possible across the heat sink fins.

NOTE: The length (and associated RF losses) of the interconnecting cables must be considered when determining the location of the ELSAT® Block Up-Converter.

## BUC Mounting

The ELSAT® Block Up-Converter is designed for mounting in any position. For optimal heat sink action, the heat sink fins should be vertical, or as nearly vertical as is practical. For Block Up-Converters equipped with a fan, this suggestion does not apply.

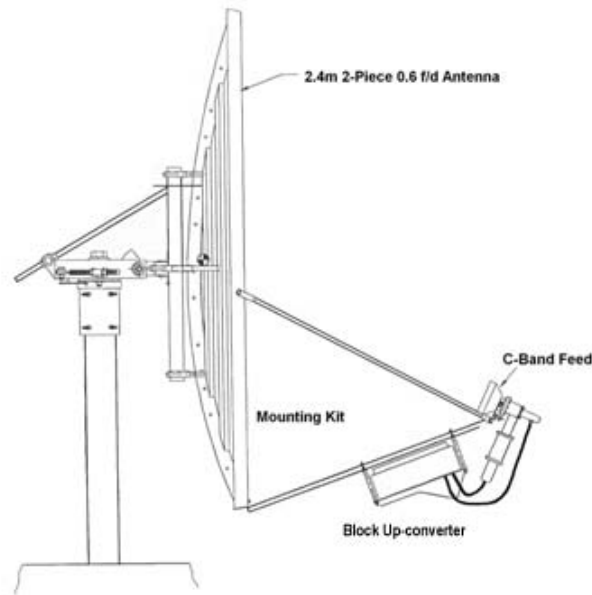

Figure 3 - Typical BUC Mounting

When mounting the BUC, allow enough room to adjust the antenna's azimuth and elevation. Throughout installation and during any polarization, azimuth, or elevation adjustment, ensure the cables and waveguide are not crimped or pinched.

### Grounding

Electrical bonding (grounding) of the BUC is required to prevent possible damage from lightning or other induced electrical surges.

The BUC is provided with both an M3, and a #8 ground point. It is recommended that 000 AWG minimum copper wire or copper braid be used to bond this unit to the earth ground (grounding rod) using the most direct (shortest) route possible.

NOTE: THIS MOUNTING KIT IS COMPATIBLE WITH ALL ANASAT TRANSCEIVERS. USER MUST MAKE SURE THE BOOM ARM OR STRUT USED TO HOLD THE ODU IS STRONG ENOUGH TO SUPPORT THE TOTAL WEIGHT OF ODU AND CABLES.

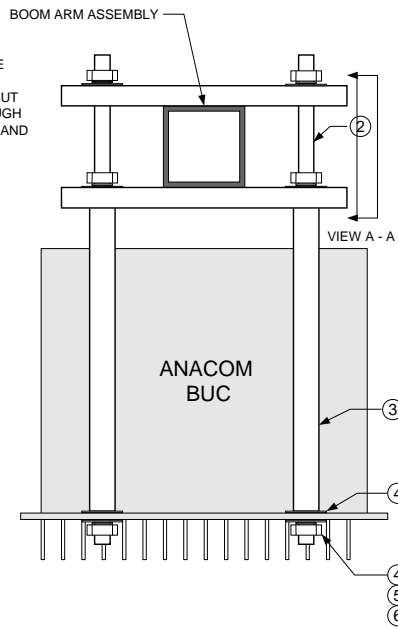

NOTE: UPPER CHANNEL CAN BE INVERTED TO ACCOMADATE LARGER BOOM SIZE IF NEEDED

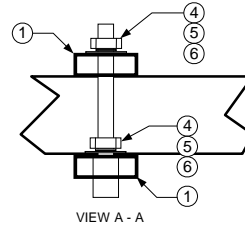

Single Universal Mounting Kit Parts List \_ 12104

ITEM	Description	QTY
1	Channel	4
2	Threaded 3/8 rod, SS, 12in long	4
3	Tube, 7in x 0.7in dia, steel	4
4	Washer, flat, 3/8 SS	16
5	Washer, split, 3/8 SS	12
6	Nut, 3/8 SS	12

<b>ANACOM INC.</b> 150 Knowles Dr. Los		
Title <b>ASSEMBLY DRAWING, SINGLE MOUNTING KIT</b>		
Size <b>B</b>	Document 31626	Rev <b>1</b>
Date 3 FEB 2003	Sheet 1 of	

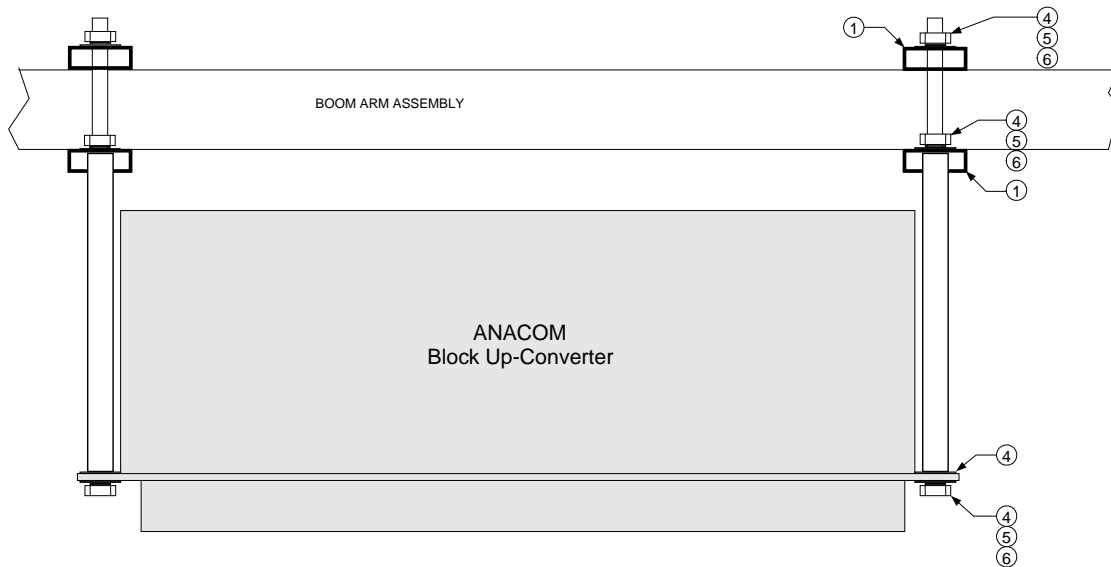

<b>ANACOM INC.</b> 150 Knowles Dr. Los Gatos, CA		
Title <b>ASSEMBLY DRAWING, SINGLE MOUNTING KIT</b>		
Size <b>B</b>	Document Number 31626	Rev <b>1</b>
Date 3 FEB 2003	Sheet 2 of 2	

Figure 4 - Front and Side Views of Mounted BUC

## Cable and Waveguide Connections

### *Cabling Requirements*

Local regulations may require that cables in occupied buildings be installed in steel conduit. Local government agencies may waive this requirement for the use of Plenum cables, which are standard cables entirely encased in solid Teflon. Check the codes in your area.

NOTE: EQUIPMENT OUTAGES DUE TO FAULTY CABLE MATERIALS OR INSTALLATION ARE NOT COVERED BY YOUR WARRANTY.

### **1. AC Power**

Attach the AC input cable to the 4-pin connector on the Block Up-Converter, shown in Figure 4. Run the AC cable to the power source *but do not attach*. The supplied power cable has a four-pin weather-tight circular connector attached to one end. The other end is terminated with flying leads. Attach the proper power connector for your location to the other end of this cable as shown in Figure 6.

### **1a. Optional Baby BUC DC Power**

Attach the DC input cable to the 5-pin connector on the Block Up-Converter, shown in Figure 5. Run the DC cable to the power source but do not attach. The supplied power cable has a five-pin weather-tight circular connector attached to one end. The other end is terminated with flying leads. Attach the proper power connector for your location to the other end of this cable as shown in Figures 7.



Figure 4 - AC Power Connection



Figure 5 - DC Power Connection

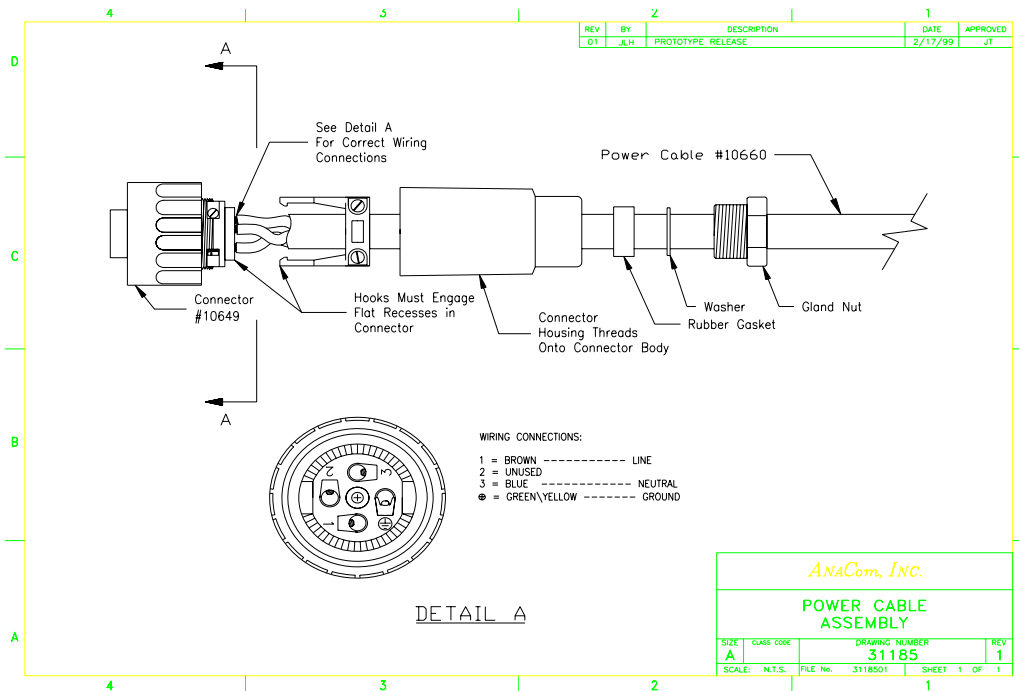

Figure 6 - Diagram of AC power cable

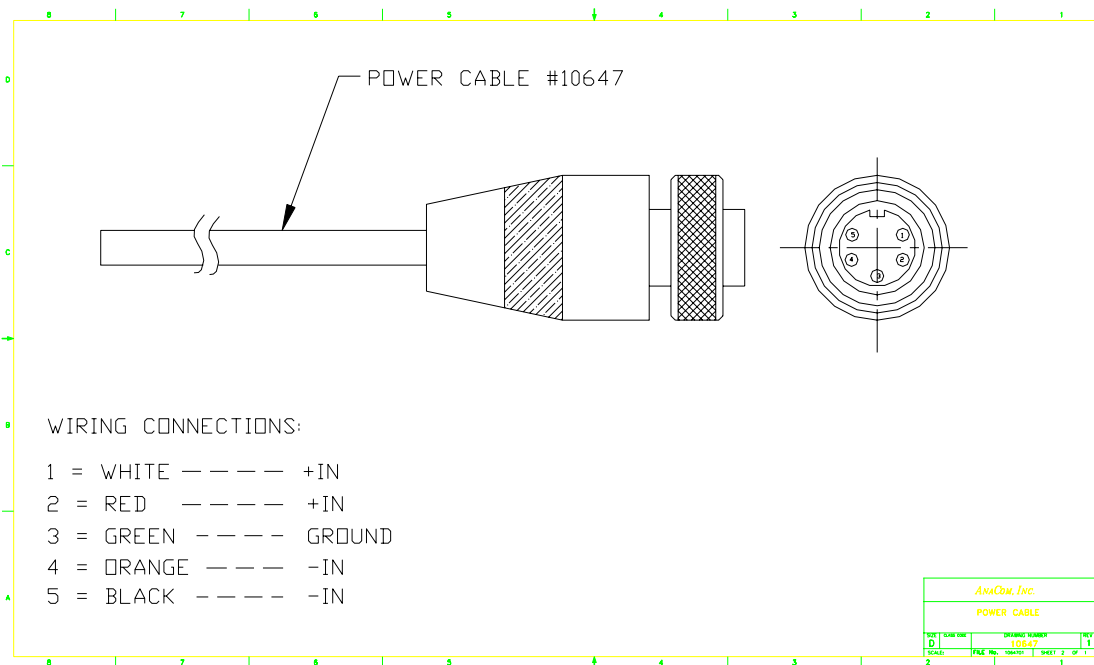

Figure 7 - Diagram of DC power cable

## 2. *Transmitter Feed*

If using a BUC with an N-type connector output, connect a section of coax between the OMT transmit port and the BUC's transmit port.

If using a BUC with a waveguide flange output port, connect a section of waveguide between the OMT transmit port and the BUC's transmit output, TX OUT. A waveguide should be attached to the antenna feed per manufacturer's instructions. Ensure a gasket is fitted at each flange and that the connections are weather-tight.

## 3. *L-Band Modem*

Attach a coaxial cable with male N-connectors between the Block Up-Converter's TX IF input and the modulator IF OUTPUT. Make sure that the connections are weather-tight.

If the BUC was ordered without an internal 10 MHz reference, then the L-Band modem is required to provide, in addition to the L-Band IF signal, a 10 MHz reference signal. See **Typical Operating Parameters** for the requirements of the reference source. Note that the accuracy and transmitted phase noise is directly dependent on the external reference. Be sure the IFL cable is well shielded from external interference.

## *Final Check*

Recheck all bolts and cabling.

After all other connections have been made (TX IF, TX output, and grounding), connect the AC power cord to an active outlet.

## *Water Resistance Wrap*

The application of moisture-resistant wrap (*mastic tape*) to all connectors is recommended to prevent water entry and resultant water damage. See Figure 8. Apply the mastic tape as follows:

1. Ensure that all connectors are tight.
2. Pre-cut the mastic tape to the desired size.
3. Center the tape on the connector to be sealed and wrap the tape tightly around the connector. Squeeze the tape tightly and ensure that both ends of the tape have formed around the connector and the cable.
4. Apply the mastic tape to all connectors that may be exposed to moisture.

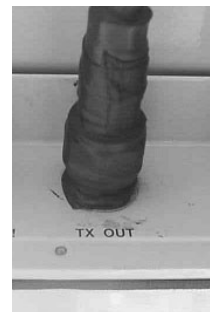

*Figure 8 - Mastic Tape Application*

## Operation

After the Block Up-converter hardware is mounted and verified, the antenna must be aimed toward the desired satellite. Follow the antenna/mount manufacturer's instructions, using coordinates provided by the satellite operator. Do not transmit until you have received authorization from the satellite network operation center, and a transmit power level from its engineering staff.



*ELSAT Block Up-Converter will produce RF output power the moment a modulator is connected and provides input.*

### Frequency Programming

Transmit operating frequency for standard C-Band frequencies is calculated with the following formula:

$$f_{TX} = TX\ IF_{IN} + 4900\ \text{MHz} \quad (\text{where } TX\ IF_{IN} \text{ ranges over } 950\ \text{MHz to } 1750\ \text{MHz})$$

Transmit operating frequency for standard Ku-Band frequencies is calculated with the following formula:

$$f_{TX} = TX\ IF_{IN} + 12800\ \text{MHz} \quad (\text{where } TX\ IF_{IN} \text{ ranges over } 950\ \text{MHz to } 1700\ \text{MHz})$$

### Antenna Adjustment



*Do not transmit while adjusting the antenna position.*

Follow the antenna manufacturer's instructions for antenna position adjustment. For final alignment, contact the satellite operator and get the correct polarization, azimuth, and elevation of the satellite and also confirm the desired transponder is operational.

### Transmit Power Adjustment

Maintaining proper output power is vital for maximizing signal-to-noise ratios over the radio path. Low power levels produce noisy signals; excessive power robs downlink strength from other stations sharing the transponder.

Adjust the modulator output level to attain the desired output power level. Use a calibrated watt meter on the output of the Block Up-Converter for this task.

When transmitting multiple carriers, run the output power with an output level back-off sufficient to meet the spectral density mask requirements.

**Caution:** It is recommended that the Block Up-Converter PA not be driven into saturation for long periods of time.

## Maintenance

ELSAT<sup>®</sup> Block Up-Converters are designed for a minimum of maintenance. Periodic scheduled maintenance is not required. Replacement of the weatherized fan after 7 years is recommended however.

## Fan Replacement



*The ducted fan shroud should NEVER be removed from the ODU while AC power is connected to the ODU. Disconnect AC power before replacing fan.*

Some units come with a weatherized fan and ducted fan shroud assembly that is attached to the PA heatsink, and is outside the block up-converter enclosure. It is fairly easy to remove the shroud from the heatsink in order to replace the fan.



*Figure 9 - Fan shroud removed from ELSAT<sup>®</sup> BUC*



*Figure 10 - Underside of ELSAT<sup>®</sup> BUC fan shroud*



*Figure 11 - Fan shroud removed from Baby BUC*



*Figure 12 - Underside of Baby BUC fan shroud*

The fan comes with a cable and three-prong connector. After the housing has been removed the heatsink, the old fan can be unplugged from the block up-converter heatsink and then removed from the shroud. A replacement fan available from AnaCom, Inc., can then be mounted on the shroud and it's connector plugged into the receptacle on the heatsink. The shroud can then be re-attached to the heatsink using the original screws.



*Figure 13 - Integrated fan and cable assembly*

## Alarm Relay Closure Option

If this option is installed, a mechanical relay is used in the BUC for alarm indication. The red LED mounted on the BUC is illuminated whenever a problem exists and the relay has closed.

The alarm relay has normally closed contacts, so it defaults to the alarm state when power is off.

### Monitored Values

The following internal points are monitored and can result in Alarm closure if out of range:

- PA temperature
- -5V DC supply (used as a bias voltage in the power amp stages)
- Each individual PA power supply
- Main +13V DC supply
- Synthesizer Lock detect
- Cooling fan failure (on units equipped with a fan)

### 18-Pin Circular Weathertight Connector

An 18-pin circular connector is used for monitoring the alarm C-Form relay. Only some of the pins are used, but the same connector is used to maintain consistency with the protection switch used in the AnaSat<sup>®</sup> product line. If the optional M&C serial port function is installed, see the AnaSat user manual for pin definitions and serial control commands.

Note dimple next to Pin 1

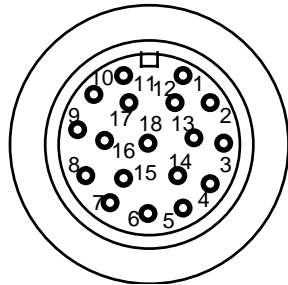

*Cable End View*

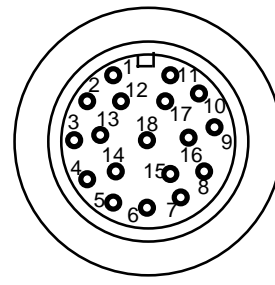

*Cable Wire View*

Pin	Signal	Description
4	NO	Alarm Normally Open
5	NC	Alarm Normally Closed
6	C	Alarm Common
7	P13V	+13V CD Power (powers protection switch)
13	Mute	Ground to turn off the TX output
18	Ground	

The *Cable End View* refers to looking into the end of the connecting cable; the *Cable Wire View* refers to looking into the connector on the BUC.

## Appendix A. M & C Command Set

The Block Up-Converter will not respond to any command until a carriage return has been entered, terminating the command input. Multiple commands may be entered before a carriage return, using “;” as a delimiter.

Example:

```
TXCHAN 54; SAVE
```

will set the transmit channel to 54, and save the change to a FLASH EEPROM. A BUC response to user input can also be delimited in similar fashion.

If a command is not recognized, an error message is returned. For example, if “foo <cr>” is entered, the following is returned:

```
??????? foo
```

## Alphabetical Listing of M & C Commands

<u>Command</u>	<u>Page</u>
ALARMS .....	23
ALARM_MODE .....	24
BAUDRATE .....	24
CLEAR_PASSWORD .....	24
CLS.....	24
CRLF .....	24
DTE .....	24
DTE0 .....	24
DTE1 .....	24
ECHO .....	25
EXTREF .....	25
INFO.....	25
LABEL .....	25
LOCK PASSWORD .....	25
MODE .....	25
MODEM_MODE .....	25
MODEM_STRING .....	26
MSG .....	26
OFFSET .....	26
PC_MODE .....	26
PORT_TO_PORT .....	26
REFRESH .....	26
RESET .....	26
SAVE .....	27
SET_PASSWORD .....	27
TERMTYPE.....	27
TX.....	27
TXREQ.....	27
TXREQUEST.....	27
TXCHAN .....	27
TXGAIN.....	28
UNLOCK PASSWORD.....	28
UTIMER.....	28
WARMUP.....	28
TXD; TXDAC.....	28

## Block Up-Converter - M & C Commands

### ALARMS

This command returns a list of raised alarms for the given transceiver. The possible alarms are: WARMING, FANERR, OSLOCK, TXLOCK, RXLOCK, UCMUTE, PATEMP, TXOUT, P12V, PA, N5V, OSLPLL, TXPLL, RXPLL, P5V, LNCV, PROMERR and RXOUT.

If there are no alarms then "ALARMS CLEAR" is returned. Status of all individual alarms is evaluated ten times a second.

Alarms are categorized as **MAJOR** and **MINOR**, major alarms cause the external red LED on the transceiver to begin flashing. If there are no alarms, the status of the transceiver is CLEAR.

### MAJOR ALARMS

OSLOCK	raised when the OFFSET PLL has lost lock
TXLOCK	raised when the TX PLL has lost lock
RXLOCK	raised when the RX PLL has lost lock
UCMUTE	raised when the hardware mute circuit on the M & C board is active (this includes external TX shutdown)
PATEMP	when the heat sink temperature exceeds approx 85oC
PA	raised when any active power amplifier voltage drops too low
N5V	raised when the -5 volt supply drops too far
LNCV	raised when the LNC supply voltage drops too far
RXOUT	raised when the RX IF output power becomes too low
PROMERR	raised if a write or erase operation in the PROM fails

### MINOR

WARMING	when the warm-up software function is active upon reset or power cycling (power turn on)
FANERR	raised when fan current becomes too low (if a fan is installed)
TXOUT	raised when PA output is deemed by software to be too high
P12V	the primary 13V supply drops below a specified level
P5V	the 5V supply on the M & C board drops below a specified level
OSLOOP	OS VCXO voltage exceeds a specified range –may still be locked
TXLOOP	UC VCXO voltage exceeds a specified range –may still be locked
RXLOOP	DC VCXO voltage exceeds a specified range –may still be locked

There are alarm conditions which can shutdown the PA stage: WARMING and OSLOCK, TXLOCK, PATEMP, and N5V. When these alarms are active, the PA stage is shutdown via the supply lines which feed it. This may cause the PA alarm to be raised as well. The WARMUP alarm may be disabled with the WARMUP command.

**ALARM\_MODE [ NORMAL | PROTECTION ]**

There are two modes for alarm relay operation: Normal and Protection. In the NORMAL mode, the relays operate as MAJOR and MINOR relays as described above. In PROTECTION mode, the relays become redefined as TX and RX summary fault relays. The relay normally called MAJOR becomes the TX relay and the relay normally called MINOR becomes the RX relay.

In normal operation, the MAJOR relay is energized so that a power fault causes the relay to relax and thus provide an alarm contact closure. The MINOR relay is normally not energized (non-alarm state). During PROTECTION operation, both relays are normally energized (no alarms). Therefore, the RX relay has reverse definition of its contacts (NO and NC) for PROTECTION operation compared to its NORMAL operation.

**BAUDRATE [ 300 | 1200 | 2400 | 4800 | 9600 | 19200 | 38400 | 57600 ]**

This command sets the baudrate of the serial channel the user is presently connected to. Both serial ports have been programmed for 8 bits, no parity and 1 stop bit. These parameters are not user changeable.

**CLEAR\_PASSWORD PASSWORD**

This command will clear an existing password. Note that the password must be given in order for it to be cleared.

**CLS**

In terminal mode, 25 line feeds are sent to the terminal, effectively clearing the screen. In VT52 and VT100 modes, CLS refreshes the display.

**CRLF [ ON | OFF ]**

This command is only relevant to dumb-terminal mode. It sets (or returns) carriage-return/line-feed status. "CRLF ON" will command the M & C computer to insert a line-feed in display output following a carriage return. This can be necessary to make some terminal displays operate properly. In other cases this would be redundant.

**DTE****DTE0 [ COMMAND ]****DTE1 [ COMMAND ]**

These commands return a string of data regarding the specified serial port. If no port is specified then the present serial port is used.

Using DTE0 and DTE1 it is possible to change some of the serial port parameters for the serial port other than the one the operator is presently connected to. This could be especially useful for baud rate. Example of operator input from a terminal attached to serial port 0:

```
dtel baudrate 19200
```

The valid commands which can be used in this fashion for the opposing serial port are BAUDRATE, TERMTYPE, ECHO, CRLF, MODEM\_MODE, PC\_MODE, and TERMINAL\_MODE.

See the explanations for those commands elsewhere in this appendix.

**ECHO [ON | OFF]**

This command is only relevant in dumb-terminal mode. It sets (or returns) character echo mode. For example, if the operator is running a terminal emulation program on his PC with local echo disabled, type

ECHO ON

to enable echo back from the M & C computer. If the terminal is displaying doubled up characters, use ECHO OFF.

**EXTREF [ON | OFF]**

If ON, the ODU is programmed to accept an optional external 10MHz frequency reference source. If one is not present, a new alarm, EXTREF is raised. When an external reference signal appears while the EXTREF alarm is raised, the alarm will be dropped.

If OFF is given, then the internal source is used regardless of whether the optional reference source switch is indicating an external source is present or not.

The default setting is EXTREF OFF.

**INFO**

Returns information about software and hardware revision numbers.

**LABEL [TEXT]**

This command erases or [sets] an alphanumeric string up to 32 characters long that the user can use to “title” or describe the purpose of the given ODU.

**LOCK PASSWORD**

With this command most M & C functions will be locked and further user access will be denied until the UNLOCK command is given. Those commands which remain user accessible are: UNLOCK, CLS, ALARMS, and LIST.

If a password has been established with the SET\_PASSWORD command then that password must be used with the LOCK command. If there is no established password (if CLEAR\_PASSWORD has been used, for instance), then M & C functions will be locked; but they can be unlocked without a password. There are two solutions to the problem of having a locked unit and/or a forgotten password:

1. The unit can be reset using the internal DIP switches. See Appendix D.
2. If the unit is attached to a modem, and presently accessible remotely, telephone ANACOM.

**MODE**

This command returns either MODEM\_MODE or PC\_MODE. Example: MODE might return MODE MODEM\_MODE when the user is connected to the unit via a phone line and a Hayes compatible modem.

**MODEM\_MODE**

This command is used to tell the M & C computer that a Hayes compatible modem is attached to the serial port. The way this would be used is a user would enter this command from a PC using a null modem cable, then disconnect the PC and attach a modem directly to the port via a modem cable. RX, TX, DCD and signal GND lines must be properly connected.

Once MODEM\_MODE is activated, the M&C computer will no longer display dumb terminal display updates or generate packets in packet mode until the DATA-CARRIER\_DETECT line becomes active, indicating the modem is off-hook and connected to another modem.

**MODEM\_STRING [TEXT]**

When the M & C computer is in modem mode it will periodically send a Hayes compatible initialization string of up to 40 characters to the modem to make sure it is properly configured. The user can get [set] this string via this command. The default string as part of factory settings is:

```
MODEM_STRING AT S0=1 &C1 &S0 \Q0 E0
```

**MSG TEXT**

This command allows an operator connected to one serial port to send an ASCII message to someone connected to the other port. A message received will appear on the other operator's screen prefixed with the prompt MESSAGE>.

**OFFSET [TXGAIN | RXGAIN] [number]**

This command gets [sets] a floating point offset for TX or RX calibration tables. The valid arguments are: TXGAIN, RXGAIN.

The default values for these offsets is 0. Example usage:

```
OFFSET TXGAIN 2
```

The result of this is that the output would be 2 dB greater than what would otherwise be transmitted. In other words, the TX gain range would be shifted down by two decibels. If a TXGAIN of 72 dB were requested, the calibration data interpolation would be done internally with the value of 74 dB. If the user measures the TX gain with a power meter and finds that gain is high by 1.5 dB, then he might enter:

```
OFFSET TXGAIN -1.5
```

**PC\_MODE**

This is the converse of MODEM\_MODE. At any time, the user may type PC\_MODE and the M & C computer will again behave as if a PC or network is directly attached to the serial port rather than a modem.

**PORT\_TO\_PORT [ON|OFF]**

This command sets (gets) the status of the port\_to\_port function. When active on, then function re-transmits all serial port data from COM0 to COM1 and also from COM1 to COM0 regardless of data content. If the M & C interprets data as a legitimate command then the command is acted on. Otherwise the data is ignored by the M & C. When ON, the M & C does not issue ??????? when data is received which does not conform to a proper command.

WARNING: When this function is ON, the M & C will not automatically change baudrate to 1200 when the external data is changed to 1200.

**REFRESH**

This command refreshes the RF hardware to presently chosen receive and transmit channels and gain settings.

**RESET**

This command resets the M & C computer. Power-on time will reset to zero. Warning: RESET will shut down the transceiver momentarily.

**SAVE**

This command saves present M & C operating parameters to a FLASH EEPROM.

**SET\_PASSWORD PASSWORD PASSWORD**

The M & C computer supports password control of M & C functions. One potential use of this feature would be for leaving an ODU connected to a modem on an open telephone line.

A valid password must be an alphanumeric string with no imbedded blanks, and between four and eight characters long inclusive. It must be given twice to ensure accuracy.

An existing password must first be cleared before setting a new password. This is done with the CLEAR\_PASSWORD command.

**TERMTYPE [TTY | VT52 | VT100] (OLD UNITS, OBSOLETE)**

This command is only relevant to dumb-terminal mode. It sets (or returns) the terminal emulation mode.

TTY Terminal Mode: this is a basic 80 character by 25 line ASCII “dumb” terminal mode.

VT52 Mode: This is a standard terminal emulation, more intelligent than TTY.

VT100 Mode: This is an enhanced communications terminal emulator with a fixed display window.

There are some control characters that will be filtered by the terminal driver when the M & C computer is in terminal mode. These control characters will be ignored in packet mode.

CTRL-E: This will erase the screen, similar to the CLS command.

CTRL-R: This repeats execution of the last Carriage return terminated command.

CTRL-Q: refer to the description of CTRL-S.

CTRL-S: Periodic screen updates will be squelched until the user has finished entering present command or hits CTRL-Q.

CTRL-BS: (Backspace) The present input command will be erased

**TX [ON | OFF]**

**TXREQ [ON | OFF]**

**TXREQUEST [ON | OFF]**

This command requests activation of the transmitter. This is done by enabling the PA supply voltages. TXREQ ON will indicate the operator’s desire to begin transmission. With no argument TXREQ simply return its present state as ON or OFF. Note that the unit will be shipped with TXREQ set to OFF.

Exactly when are we “ON AIR?” The answer is when TXREQ is ON, the hardware alarm TXMUTE is clear, and the transmitter is not software inhibited to allow the crystal reference oscillator time to warm-up at power-on. See the WARMUP command for details.

**TXCHAN [number]**

This command gets [sets] the transmit channel number. The acceptable range depends upon model type. See Appendix E for channel frequency information. *Channel 0 is not a valid selection.*

**TXGAIN [number | INC | DEC]**

This command gets [sets] or returns the transmit power amplifier gain. The acceptable range of the number is dependent upon model.

nn ranges from nominal value +/- 10

**UNLOCK PASSWORD**

This command will unlock M & C functions for user access.

**UTIMER [NUMBER]**

This command is only relevant to dumb-terminal mode. It sets (or returns) the number of seconds between automatic display updates. Note that changing baud rate will automatically revert to a default appropriate for that particular baudrate.

**WARMUP [ON | OFF | CANCEL]**

Upon transceiver power-up, a 5 minute period will pass to allow the reference oscillator crystal oven sufficient warm up time. The unit is shipped with this flag set OFF, but can be changed by the user. Because there is no way for the M & C computer to know how long it has been off the air, a reset or momentary loss of power will cause a warm-up countdown to occur when the feature is in use. WARMUP CANCEL will terminate a warm-up countdown and immediately enable the transmitter.

**TXD; TXDAC [NUMBER]**

This command bypasses the transmit numerical gain compensation by the M&C. It will issue [number] 1 to 255 to the TX gain control element. This is for troubleshooting use only and transceiver should not be left in this mode as the numerical compensation (temp. + freq.) would be disabled.

## Appendix B. ARM9 M&C Card Connection Methods

ELSAT BUCs and Baby BUCs with the optional ARM9 M&C board support multiple connection methods, which are outlined below

### Serial Port Methods

All of these methods can be used with AnaCom's Supervisor application, which can be downloaded from our website: [http://anacominc.com/prod\\_sw.html](http://anacominc.com/prod_sw.html).

#### **RS-232**

Available when the cable **P/N 31336** is used and plugged from the 18-pin connector on the BUC chassis to a 9-pin serial port, or a USB to serial port adapter on the user's laptop/computer.

An ASCII terminal program is required to make use of a serial port connection; options are **Supervisor 9**, **RealTerm**, and **HyperTerminal**.

RealTerm can be downloaded from: <http://realterm.sourceforge.net/>.

**Typical usage:** a laptop connected to a single ODU through a short cable, 10' for setup purposes.

#### **RS-485**

Available when the cable **P/N 31415** is used. This cable contains an RS-485 to RS-232 converter, and plugs into a 9-pin connector on the user's computer or USB to serial port adapter.

AnaCom's Supervisor application or a third-party NMS is typically used with an RS-485 connection.

**Typical usage:** a laptop/computer connected to a single ODU or multiple ODUs and a protection switch through a long cable. Such a setup is often more permanent with the monitoring computer serving as part of the indoor installation.

#### **FSK**

This is a new method introduced with the ARM9 M&C card, and uses FSK signals on the TXIF cable. At present only the AnaCom packet protocol is supported using FSK, but we expect to support other protocols as requested and provided.

FSK runs at 9600 baud, and a circuit is required to take the signal off the TXIF line, and convert it to a standard such as RS-232. Supervisor works over FSK, provided there is an FSK to serial port converter. AnaCom will be able to provide that as an option in the near future.

## Ethernet-based Methods

All Ethernet-based methods of communication require cable **P/N 32999**. This cable has a weather-proof 18-pin connector on one end and a standard Ethernet connector on the other end. It is not possible to run both an RS-485 serial port connection and an Ethernet-based connection at the same time, as these two methods share pins in the connector. The connection method used by the ARM9 will switch automatically between RS-485 and Ethernet, depending on which cable has been plugged into it.

When an Ethernet cable is being used to connect a BUC to a network, all Ethernet-based monitoring and control methods can be used at the same time. This includes Supervisor, a telnet session, a web browser monitoring the BUC's web page, an SNMP device manager polling for status, etc.

Most Ethernet network traffic uses an IP protocol and therefore requires a device to have an IP address. AnaCom BUCs are shipped with a default address of 0.0.0.0. When a BUC with this address is placed on a network, it will use the DHCP protocol to acquire an address from the local router.

There are some new commands that have been added to the M&C firmware to support IP-based communication:

**DHCP [HELP | RENEW | ASSIGN]**

**HELP** Prints the following directions:

Manual DHCP process:

Step 1: send **DHCP RENEW** to start a DHCP request.

Wait about 10 seconds for this to complete.

Step 2: send **DHCP** to make sure a new IP address was acquired.

At this point, new address has NOT been used or saved.

Step 3: send **DHCP ASSIGN** to program the ODU to the new address.

Wait about 5 seconds, then connect on the new address.

**IP\_ADDR [IP ADDRESS]**

**IP ADDRESS**

A specific IP address can be assigned manually if desired. With no argument, this command will print the present IP address being used by the BUC. The address can also be reset to 0.0.0.0 using this command.

## Supervisor 9

Supervisor 9 can manage multiple serial port connections and ethernet connections at the same time. It is not necessary for BUCs to have IP addresses, nor is it necessary for there to be a DHCP server in order for Supervisor to find and manage any number of BUCs on the local network. A switch connecting all the BUCs together, with a computer running Supervisor 9, or a direct Ethernet cable running from a single BUC to a computer is all that is necessary. Supervisor 9 implements a robust protocol for finding and managing however many BUCs are on the local network. Dashboard-type displays are generated for each BUC it finds.

This software application can be downloaded from: [http://anacominc.com/prod\\_sw.html](http://anacominc.com/prod_sw.html).

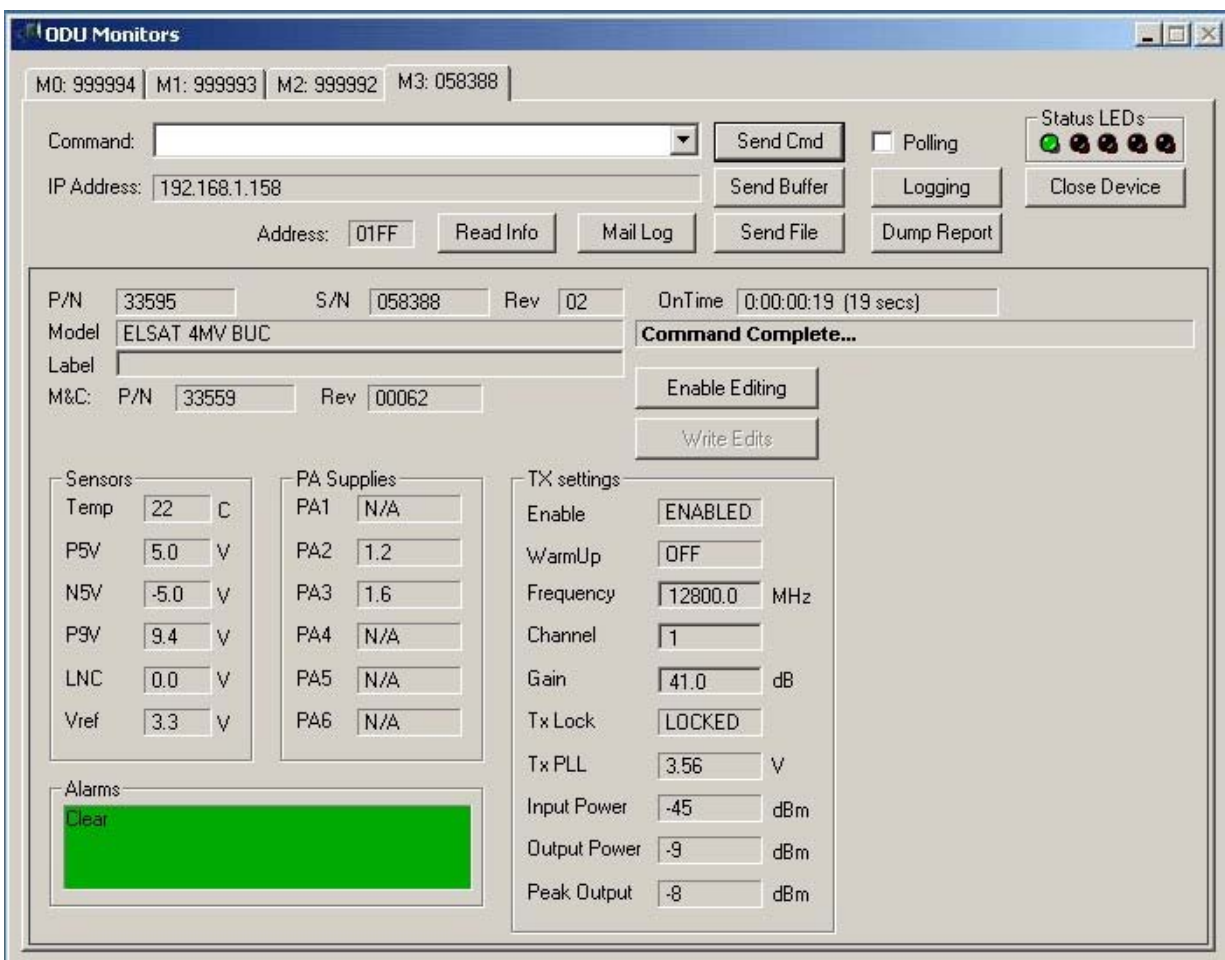

Example of Supervisor 9 monitoring BUCs

## *Telnet*

This is a terminal emulator method that works over Ethernet. Such a method can be used for initial setup, or to send commands while another method is be used to monitor the BUC while unattended.

A good telnet program for Windows, is known as PuTTY, and more can be learned about it here: <http://en.wikipedia.org/wiki/PuTTY>.



```
192.168.1.158 - PuTTY
AnaCom ODU terminal shell
COMMAND> id

  ELSAT 4MW BUC REV:02 S/N:058388
TXREQ on ITX ON AIR
ALARM:CLEAR last reset: 905 seconds
  TXin -43
TXG 41.0 TXout -11
  TXpk -10
XTAL:normal TXMUTE: clear TXLOCK: locked TXPLL: 4.7
TEMP: 38C FANERR:clear P9V: 9.4 P11V:N/A P5V: 5.0 N5V:-5.0
PA 2: 1.1 PA 3: 1.5

COMMAND> █
```

*Example of a telnet session using PuTTY*

## HTTP (web browser)

By entering a BUCs IP address into a browser's URL field (IE, Firefox, Chrome, and Opera have all been tested), the BUC provides a web page which can be used to monitor and control its function. Once connected, the web page can be set to refresh periodically. Multiple browsers on different computers can be monitoring a BUC's web page simultaneously. A browser can be used to monitor multiple BUCs by opening a separate browser tab for each BUC.

The screenshot shows a web browser window with the following content:

- Browser Tabs:** AnaCom, Inc., S/N 058388, S/N 999990
- Page Title:** Welcome to the Anacom ODU M&C utility
- Device Info:** INFO S/N:058388 P/N:33595 REV:02 "ELSAT 4MV BUC", LABEL: "", M&C SOFTWARE: P/N:33559 REV:00062
- ALARMS:** CLEAR (green bar)
- Command:**   **Auto-Refresh (Secs):**
- Sensors:**
  - Temp = 30 degsC
  - P5V = 5.0 V
  - N5V = -5.0 V
  - P9V = 9.4 V
  - LNC = 0.0 V
  - Vref = 3.3 V
  - OnTime = 1239 seconds
- PA Supplies:**
  - PA1 = N/A
  - PA2 = 1.1 V
  - PA3 = 1.5 V
  - PA4 = N/A
  - PA5 = N/A
  - PA6 = N/A
- TX Params:**
  - Tx Enabled = ON
  - Warmup = OFF
  - Frequency = 12800.0 MHz
  - Channel = 1
  - Gain = 41.0 dB
  - Tx Lock = LOCKED
  - Tx PLL = 4.01 V
  - Input Power = -44 dBm
  - Output Power = -10 dBm
  - Peak Output = -10 dBm
- RX Params:** (Empty)
- Footer:** Auto-refresh of this page is disabled, Last Refresh: Wednesday, May 26, 2010 14:42:14, These pages are Copyright (c) 2010 Anacom Inc

Example of Internet Explorer rendering the web page

## SNMP

Simple Network Management Protocol is an IP protocol used by NMS programs. It is a standardized means by which arbitrary devices from different vendors on a network can be monitored from a central location.

A simple demonstration application that shows the SNMP interface in operation can be downloaded from: [http://anacominc.com/prod\\_sw.html](http://anacominc.com/prod_sw.html). The file provided is a complete installer for Microsoft Windows.

In order for SNMP to work, a file called a MIB, (Management Information Base,) must be provided to the NMS software for each device type. This file is used to describe all the data that can be read out of a device and those parameters which can be written to, using SNMP.

AnaCom will provide a MIB for all devices that we support to any NMS vendor. The associated AnaCom OID is 1.3.6.1.4.1.4578.

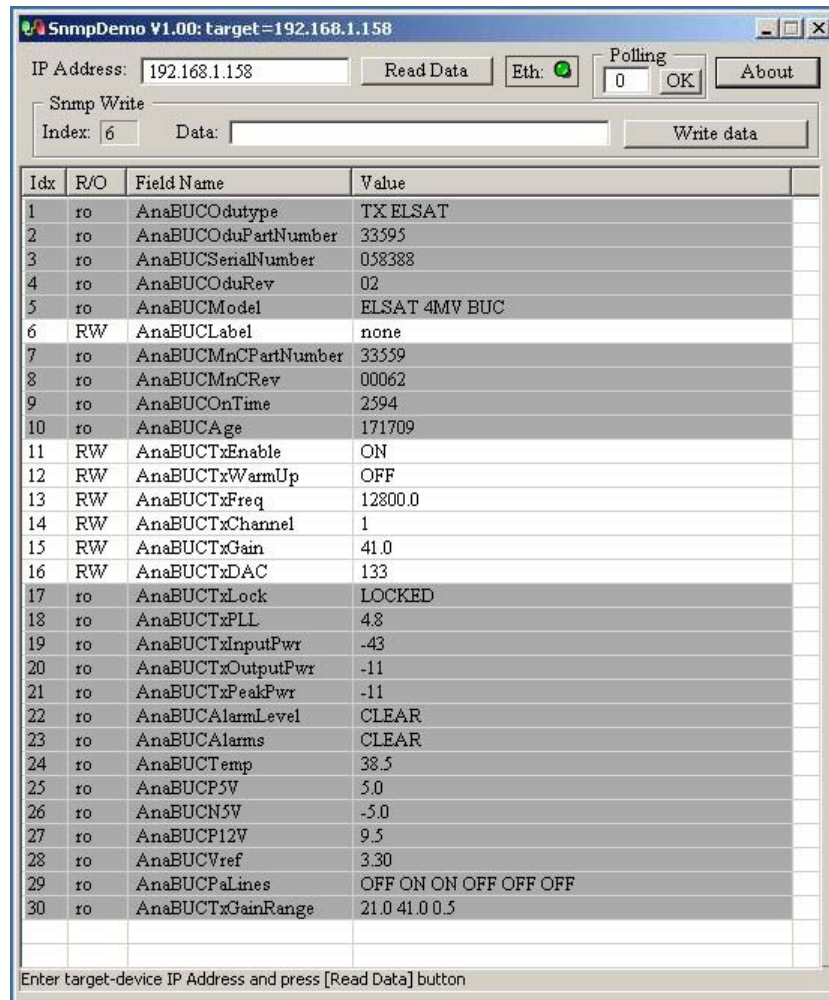

Example of using the SnmpDemo program to demonstrate the SNMP interface

## LIMITED WARRANTY

If this product should fail due to defects in materials or workmanship, AnaCom, Inc., will, at its sole option, repair or replace it with new or rebuilt parts free of charge for a period of two (2) years from the date of shipment from the AnaCom factory. This warranty covers only failures due to defects in materials and workmanship that occurs during the period of the warranty. It does not cover damage that occurs during shipment, failure caused by operation of the product outside the published electrical or environmental specifications, or malfunctions caused by misuse of the product. Expendable components are not covered under this warranty.

In order for the customer to exercise their rights to repairs under the warranty, the customer must first contact AnaCom to obtain a repair authorization number (RMA). If it is necessary to return the product for repair, the customer is responsible for paying the cost of shipping it to AnaCom. AnaCom will pay the cost of shipping the product back to the customer when the repairs are completed. All import duties, customs fees, taxes of any kind, or any related fees are the sole responsibility of the customer.

Spare parts, repairs, or replacements are warranted to be free from defects in material or workmanship for ninety (90) days or the remainder of the limited warranty period, whichever is longer.

There are no express or implied warranties except as listed above. In no event shall AnaCom be liable for special, incidental, or consequential damages arising from the use of this product, or arising out of any breach of this warranty. All express and implied warranties, including the warranties of merchantability and fitness for a particular purpose, are limited to the applicable warranty period set forth above. No employee or representative of AnaCom is authorized to modify this warranty or AnaCom's standard warranty for any product.

Non-warranty repair service is available from AnaCom for a nominal charge. Non-warranty repair service can be obtained by contacting AnaCom and requesting a return authorization number (RMA), as described above. The customer is responsible for paying the cost of the shipping to and from AnaCom for any non-warranty repairs. Non-warranty repair service will be available for any AnaCom product for a minimum of five years from the date of its first shipment from AnaCom's factory.